

INNOVATION et DIVERSIFICATION

Voici la philosophie d'entreprise de **MERIGOUS** qui depuis 1954 fabrique de la porcelaine avec un **savoir-faire** qui lui vaut d'être labellisée **Entreprise du Patrimoine Vivant**.

Leader français en poignées de porte et boutons de meuble en porcelaine de Limoges, l'entreprise familiale MERIGOUS collabore avec de nombreux artistes (designers, plasticiens) de renommée internationale et travaille pour des industriels dans des domaines très variés.

Troisième génération de porcelainiers, les dirigeants actuels : Evelyne et Laurent **MERIGOUS** ont constitué une équipe de femmes et d'hommes tous très attachés à la **qualité** de leur **fabrication**.

Les marchés de référence sont naturellement localisés en France mais s'étendent aussi à toute l'Europe et au reste du monde.

Découvrez la gamme **MERIGOUS** classifiée en quatre chapitres auxquels il convient d'ajouter celui de « **fait sur mesure** » dans lequel les références, les expériences et les réalisations en **workshop** sont évoquées.

En favorisant des relations durables, basées sur la confiance avec les fournisseurs, le personnel et les clients, **MERIGOUS** poursuit son travail de qualité tout en veillant aux problèmes **d'environnement et de commerce équitable**.

« *Tous nos produits sont protégés au titre de la propriété littéraire et artistique et par dépôts de dessins et modèles* »



INNOVATION and DIVERSIFICATION

*Such is the philosophy of the company **MERIGOUS** which, as a Limoges porcelain manufacturer since 1954, has been branded **EPV** by the **French government** for its confirmed **know-how**.*

***French leader in building decorative hardware, cupboard knobs and bathroom accessories made of Limoges porcelain**, this family firm collaborates with many internationally known designers and works for various fields of industry.*

*Third generation of porcelain manufacturers, the current directors: Evelyne and Laurent **MERIGOUS** have set up a team of women and men all very concerned with the **quality** of their **manufacture**.*

***MERIGOUS** sells mainly in France but is also present in the EEC and in the rest of the world.*

*By establishing long-lasting relationship with the suppliers, staff and customers, founded on trust, **MERIGOUS** continues to manufacture the best quality while watching out for **environmental issues** and **fair trade practices** to which **MERIGOUS** fully adheres.*

*Discover our standard range classified in four chapters to which we add our "**made-to-measure**" products which relate to some of the achievements in our **workshop**.*

Do not hesitate to contact our design office or marketing department for any technical questions adapted to your needs.

« All our products are covered by artistic and author's copyright and our drawings and models are registered »

QUINCAILLERIE DE BATIMENT 5***Pour la PORTE***

1 - Poignées de porte	
a) béquille (bec de cane, clenche)	
sur plaque.....	7
sur rosace (à visser, à clipser, dia 65).....	6
sans plaque et sans rosace.....	11
b) boutons de porte	
sur plaque.....	9
sur rosace (à visser, à clipser, dia 65, à visser, à fixer).....	8
sans plaque et sans rosace.....	13
2 - Rosaces de fonction (trou de clé L, I, condamnation, décondamnation).....	10
3 - Manivelle bordelaise, poignées GEMA.....	12

Pour la FENETRE

1- CREMONE béquille sur platine et boitier.....	14
2- CREMONE bouton sur platine et boitier.....	15

Les GAMMES

UNI BLANC 11.....	6 à 15
LEM 12.....	16
RETRO 15.....	16
PERLE 17.....	17
REGENCE 19.....	17
UNI FINITION INOX 11.....	18
BELLEGARDE 63.....	19
TOC TOC 24.....	20 à 25
DELO LINDO 50.....	26 à 27
UNI COULEUR 11.....	28 à 29
UNI ACIDULE 11.....	30
UNI CHARME 11.....	31
UNI NOIR ET BLANC 11.....	32
UNI TRADITION 11.....	33
UNI DECORE 11.....	34 à 35
CRAQUELE 11.....	36
SHERAZADE 11.....	37
TERRA COTTA 11.....	38
LOSANGE 11.....	39
SURF 16.....	40
MANDALIS 25.....	41
MANDARINE 18.....	42
OCTOMA 13.....	43
STYLE 14.....	44
HECTOR GUIMARD 48.....	45
HB HENRIOT 26.....	46
CRISTOBAL de RAYNAUD pour Alberto PINTO 27.....	47
DORIQUE 29.....	48
FUSAIN 32.....	48 à 49

Accessoires PORTES et FENETRES

Tiges carrées, visserie.....	50
------------------------------	----

QUINCAILLERIE D'AMEUBLEMENT 51**ACCESSOIRES DE SALLE DE BAIN 65****DIVERS 69**

SIGNALETIQUE (intérieure, extérieure).....	70
BOULE DE RAMPE.....	70
BOUTON DE CHAINETTE.....	70
POIGNEE DE TIRAGE.....	70
BIJOUX (boucles d'oreille, pendentifs, boutons de manchette).....	71
PLAQUES OVALES, RECTANGULAIRES, RONDES, HUMIDIFICATEURS.....	71 à 72
MAGNETS.....	72
ENCRIER.....	72
COMPOSANTS de ROBINETTERIE (pied de robinet, croisillons, manette d'inverseur, manche de douche).....	72
PASTILLES de ROBINETTERIE (de nombreuses tailles et formes disponibles).....	72

« SUR MESURE » 73

MERIGOUS a de nombreuses références dans des secteurs aussi divers que BIJOUX de CREATEURS, PORCELAINE TECHNIQUE, MOBILIER URBAIN, FUNERAIRE, MUSIQUE, CULINAIRE, (MAROQUINERIE, MODE, PRET A PORTER), DESIGN et HABITAT, et de nombreuses expériences avec des DESIGNERS de renommée internationale..... 74

Veuillez nous consulter pour toute étude de votre projet...

BUILDING DECORATIVE HARDWARE 5***DOOR FURNITURE***

a) LEVER HANDLES	
On fingerplates.....	7
On roses.....	6
Lever handles only.....	11
b) KNOBS	
Sets on fingerplates.....	9
Sets on roses.....	8
Knobs only.....	13
c) ROSES.....	10
d) Special handles and knobs ("bordelaise" door handles).....	12

WINDOW FURNITURE

1 - Handles for window.....	14
2 - Knobs for window.....	15

LINES

UNI BLANC 11.....	6 to 15
LEM 12.....	16
RETRO 15.....	16
PERLE 17.....	17
REGENCE 19.....	17
UNI INOX FINITION 11.....	18
BELLEGARDE 63.....	19
TOC TOC 24.....	20 to 25
DELO LINDO 50.....	26 - 27
COLOR 11.....	28 - 29
FLASHY COLOR 11.....	30
CHARM 11.....	31
BLACK & WHITE 11.....	32
TRADITION 11.....	33
UNI DECOR 11.....	34 - 35
CRACKELED 11.....	36
SHERAZADE 11.....	37
TERRA COTTA 11.....	38
LOSANGE 11.....	39
SURF 16.....	40
MANDALIS 25.....	41
MANDARINE 18.....	42
OCTOMA 13.....	43
STYLE 14.....	44
HECTOR GUIMARD 48.....	45
HB HENRIOT 26.....	46
CRISTOBAL ALBERTO PINTO 27.....	47
DORIQUE 29.....	48
FUSAIN 32.....	48 - 49

ACCESSORIES for DOOR and WINDOWS

Square spindles, screws, sleeves etc.....	50
---	----

CUPBOARD KNOBS 51**BATHROOM ACCESSORIES 65****MISCELLANEOUS 69**

Sign plates.....	70
Staircase knobs.....	70
Center door knobs.....	70
Pull handles.....	70
Jewels.....	71
Oval, rectangular, round small plates, humidifier.....	71- 72
Magnets.....	72
Ink stand.....	72
Taps, faucets components (pop up knobs, handles, shower handles).....	74

WORKSHOP 73

Merigous has many references in various fields as creative jewellery,..... 74
technical ceramic, electric appliances, street furniture, funeral accessories,
musical instruments components, culinary art, fashion - fancy leather goods -
ready to wear clothes, design and habitat. We work closely with internationally-
renowned designers.

Please consult us for assistance with any of your projects.



Lexique / Lexicon

Fonction / Function



TB Clé L Clé I BC BD

Carré / Square spindles



6 7 8

Entraxes disponibles sur demande / Available entraxes

EA 72mm - EA 78mm - EA 110mm

Présentation / Packing

V : Vrac Sachet Plastique / Polybag

C : Carte Blister ou Cale Carton / Skin pack or on cardboard

B : Boîte cristal ou Boîte carton / Crystal box or cardboard

Finition / Finish



L : Laiton poli non verni
Solid polished brass
020



N : Nickelé
Nickeled brass
019

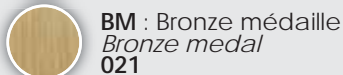

BM : Bronze médaille
Bronze medal
021



FG : Fer Gris
Worked iron aspect
023



RO : Rouillé
Rusty aspect
024



PVD : Traitement PVD
Physical vapor deposition
025



INOX : Finition INOX
Stainless steel aspect
028



LS : Laiton Satiné
Satin brass
027



NS : Nickel Satiné
Satin nickel brass
029



NM : Nickelé Mat
Matt nickeled brass
022

Système de montage / Mounting system

G : Goupille / Nail system

V : Vis pointeau / Socket screw mounting

M : Montage à griffe (monobloc) / Clip mounting system

Goupille
Nail



Vis pointeau
Socket screw mounting

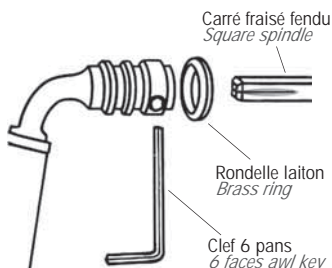

Montage monobloc
Clip mounting

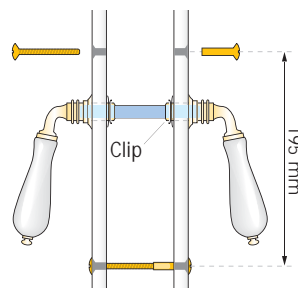

Quincaillerie
de bâtiment
Building decorative hardware

UNI BLANC - WHITE

Béquilles sur rosaces - *Leverhandles on roses*



Finition / Finish

L 020		N 019	
BM 021		FG 023	
RO 024		PVD 025	
NM 022			

Carré / Square spindles





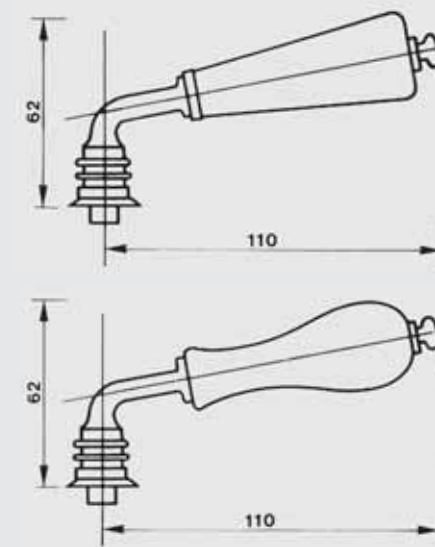



N'oubliez pas de commander la visserie
Do not forget to order screws



Les références des béquilles mentionnées sont en C/7, merci de spécifier si vous souhaitez C/6 ou C/8
The handle article codes are with square 7, please specify if you want square 6 or 8

Finition / Finish

L 020		N 019	
BM 021		FG 023	
RO 024		PVD 025	
NM 022			

Carré / Square spindles



Fonction / Function



N'oubliez pas de commander la visserie
Do not forget to order screws

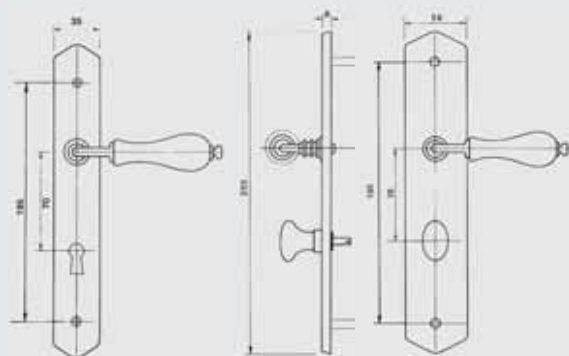

Existe également en plaque étroite 35 mm
Also exists in width 35 mm

Les références des béquilles mentionnées sont en C/7, merci de spécifier si vous souhaitez C/6 ou C/8
The handle article codes are with square 7, please specify if you want square 6 or 8



Canon - Conic
N
V6311 11 100V

V0101 11 100



Canon - Conic
FG
V6328 11 100V

V0106 11 100



Poire - Pear
RO
V6325 11 100V

V1106 11 100



Poire - Pear
L
V6340 11 100V

V0116 11 100

UNI BLANC - WHITE

Boutons sur rosaces - *Door knobs on roses*



Ovale - *Oval*
N

V7340 11 100



Rosace / *Rose*
Ø 50mm

Rond - *Round*
N

V7340 11 100



Ovale - *Oval*
N

V7363 11 100



Rosace / *Rose*
Ø 65mm

Rond - *Round*
N

V7363 11 100



Ovale - *Oval*
L

V7380 11 100



Rosace clipsante
Concealed rose
Ø 50mm

Rond - *Round*
L

V7380 11 100

Finition / *Finish*

L 020		N 019	
BM 021		FG 023	
RO 024		PVD 025	
NM 022			

Carré / *Square spindles*





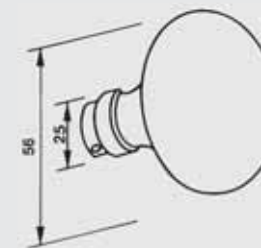
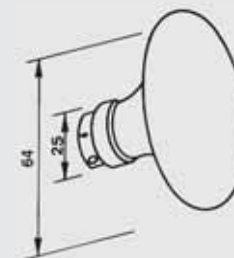



N'oubliez pas de commander la visserie
Do not forget to order screws



Les références des béquilles mentionnées sont en C/7, merci de spécifier si vous souhaitez C/6 ou C/8
The handle article codes are with square 7, please specify if you want square 6 or 8

Finition / Finish

L 020		N 019	
BM 021		FG 023	
RO 024		PVD 025	
NM 022			

Carré / Square spindles



Fonction / Function



N'oubliez pas de commander la visserie
Do not forget to order screws

Existe également en plaque étroite 35 mm
Also exists in width 35 mm

Les références des béquilles mentionnées sont en C/7, merci de spécifier si vous souhaitez C/6 ou C/8
The handle article codes are with square 7, please specify if you want square 6 or 8



Ovale - Oval
L
V3240 11 100V

V0101 11 100

UNI BLANC - WHITE

Boutons sur plaques - Doorknobs on fingerplates



Rond - Round
L
V3210 11 100V

V0100 11 100

UNI BLANC - WHITE

Rosaces de fonction - *Roses*

Rosace ø 50 mm à visser
Rose ø 50 mm with screws



V7350 11 100



V6365 11 100



V7341 11 100



V7343 11 100

Rosace ø 50 mm clipsante
Concealed rose ø 50 mm



V7381 11 100



V7384 11 100



V7382 11 100



V7383 11 100

Rosace ø 65 mm à visser
Rose ø 65mm with screws



V7366 11 100



V7363 11 100
+ V4231 11 100



V7367 11 100



V7368 11 100

Rosace ø 50 mm sans trou de fixation
Rose ø 50 mm no fixing holes



V7350 24 100



V6365 24 100



V7341 24 100



V7343 24 100

Finition / Finish

L 020		N 019	
BM 021		FG 023	
RO 024		PVD 025	
NM 022			

Fonction / Function







TB	Clé L	Clé I	BC	BD

N'oubliez pas de commander la visserie
Do not forget to order screws



Les références des béquilles mentionnées sont en C/7, merci de spécifier si vous souhaitez C/6 ou C/8
The handle article codes are with square 7, please specify if you want square 6 or 8

Finition / Finish

L 020		N 019	
BM 021		FG 023	
RO 024		PVD 025	
NM 022			

Carré / Square spindles

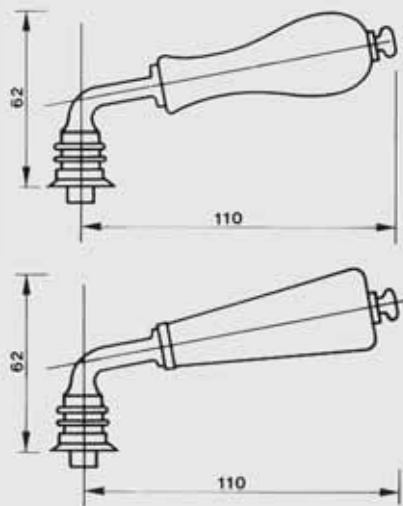

Les références des béquilles mentionnées sont en C/7, merci de spécifier si vous souhaitez C/6 ou C/8
 The handle article codes are with square 7, please specify if you want square 6 or 8

UNI BLANC - WHITE Béquilles seules - Leverhandles



Poire - Pear
 L
 V6342 11 100V



Poire - Pear
 N
 V6343 11 100V



Canon - Conic
 N
 V6313 11 100V



Canon - Conic
 L
 V6312 11 100V

UNI BLANC - WHITE

Manivelles bordelaises - *Bordelaise door knobs*



V5400 11 100



V7340 40 023

V5408 11 100



V7340 40 024

V5407 11 100

Finition / Finish

L
020



N
019

FG
023



RO
024

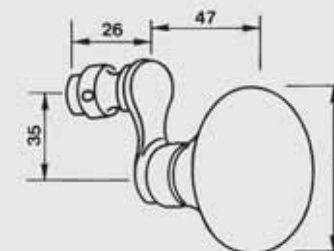

Voir nuancier p. 4
See colours chart p. 4

Les références des béquilles mentionnées sont en C/7, merci de spécifier si vous souhaitez C/6 ou C/8

The handle article codes are with square 7, please specify if you want square 6 or 8

Poignées GEMA - *GEMA short handle*



V6610 11 100V

V0522 40 020



V6611 11 100V

V7340 40 019

Finition / Finish

L
020



N
019

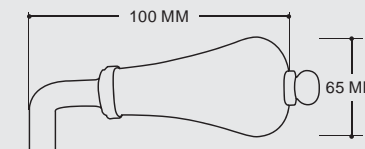







Voir nuancier p. 4
See colours chart p. 4

N'oubliez pas de commander la visserie
Do not forget to order screws

Les références des béquilles mentionnées sont en C/7, merci de spécifier si vous souhaitez C/6 ou C/8

The handle article codes are with square 7, please specify if you want square 6 or 8

Finition / Finish

L 020		N 019	
BM 021		FG 023	
RO 024		PVD 025	
NM 022			

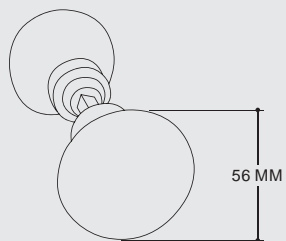
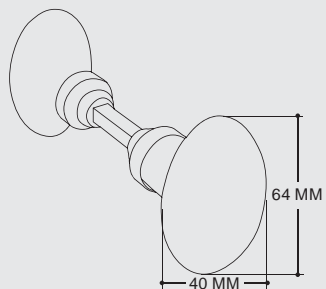

UNI BLANC - WHITE
Boutons doubles - *Door knobs*



Ovale - *Oval*
N
V3233 11 100G



Rond - *Round*
L
V3202 11 100V



Ovale - *Oval*
L
V3232 11 100V

UNI BLANC - WHITE

Béquilles pour fenêtre - Window handles

Platine classique
Traditional rose
N



V5383 11 100

Platine moderne*
*Modern rose**
N



V5371 11 100

Platine OB**
*PVC carpentry***
L



V5384 11 100







Finition / Finish

L 020		N 019	
BM 021		FG 023	
RO 024		PVD 025	
NM 022			

*n'existe pas en FER GRIS
Does not exist in FG

**n'existe qu'en LAITON
Exists only in L

Finition / Finish

L 020		N 019	
BM 021		FG 023	
RO 024		PVD 025	
NM 022			

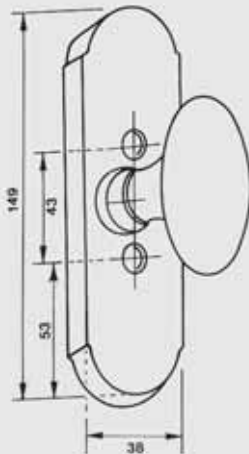
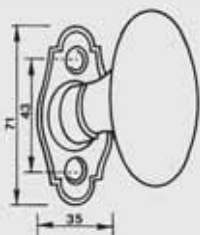

*n'existe pas en FER GRIS
Does not exist in FG

**n'existe qu'en LAITON
Exists only in L

Boîtier*
*Traditional case**
N



V5399 11 100

Platine classique
Traditional rose
L



V5387 11 100

UNI BLANC - WHITE

Boutons pour fenêtre - Window knobs

Platine moderne*
*Modern rose**
N



V5398 11 100

Platine OB**
*PVC carpentry***
L



V5368 11 100

LEM 12



V6310 11 100V

V0101 12 100

RETRO 15



PERLÉ 17

Finition / Finish



Couleurs disponibles / Available colours

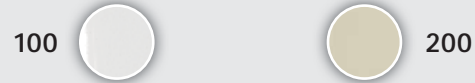

Carré / Square spindles



Fonction / Function



Perlé 17

Régence 19

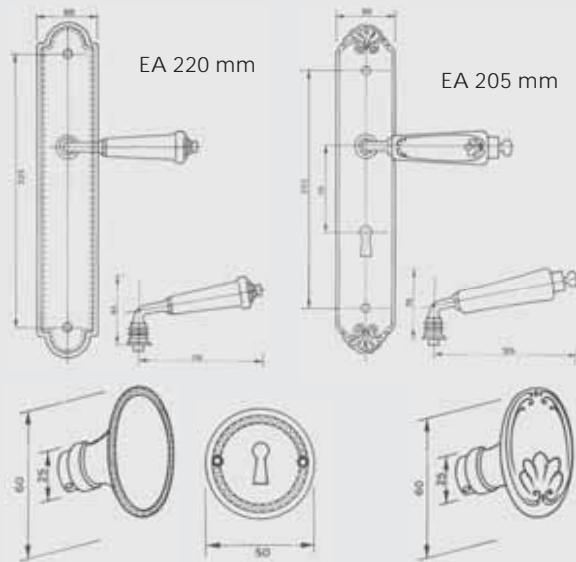

N'oubliez pas de commander la visserie
Do not forget to order screws

Les références des béquilles mentionnées sont en C/7, merci de spécifier si vous souhaitez C/6 ou C/8

The handle article codes are with square 7, please specify if you want square 6 or 8



V6310 17 100V

V3240 17 100V

V7340 17 100



V7350 17 100

V0106 17 100

RÉGENCE 19



V6310 19 100V

V5387 19 100

V0106 19 100

UNI BLANC - WHITE

Inox - *Inox finish*

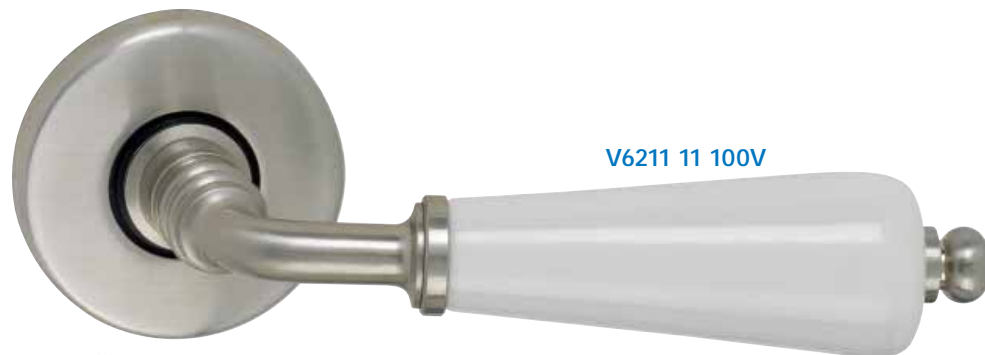

V6211 11 100V

V7380 40 028

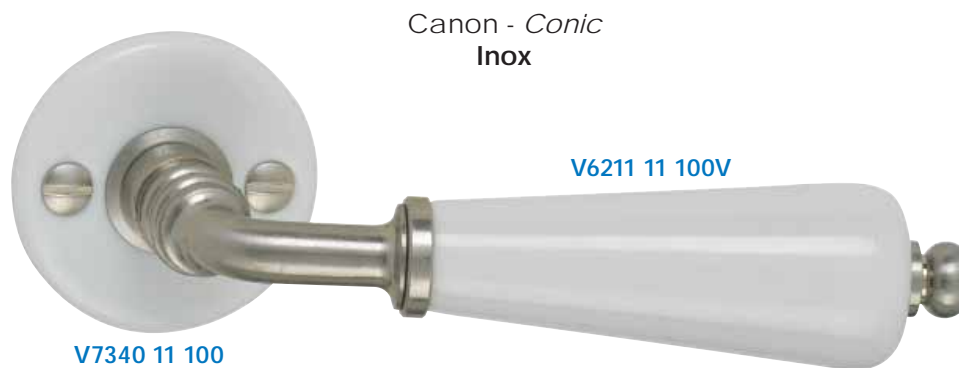

Canon - *Conic*
Inox

V6211 11 100V

V7340 11 100

Ovale - *Oval*
Inox

V3249 11 100V



V7340 11 100

Pour fenêtre - *For window*
Inox



V5366 11 100

Nous obtenons l'aspect de l'inox sur une base laiton
This inox colour is obtained on a brass base

Carré / *Square spindles*



Fonction / *Function*

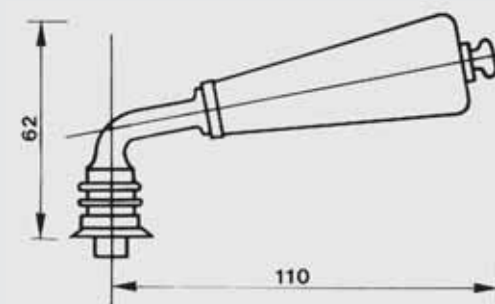
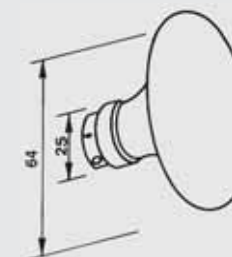

N'oubliez pas de commander la visserie
Do not forget to order screws

Les références des béquilles mentionnées sont en C/7, merci de spécifier si vous souhaitez C/6 ou C/8

The handle article codes are with square 7, please specify if you want square 6 or 8

Carré / Square spindles



Fonction / Function



Nous déclinons toute responsabilité sur l'utilisation de ces produits sur des portes équipées de serrures nécessitant un relevage.

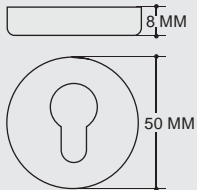
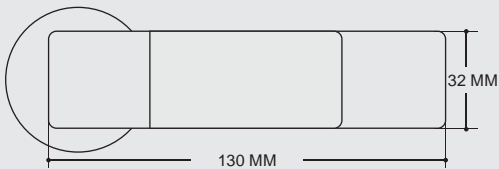
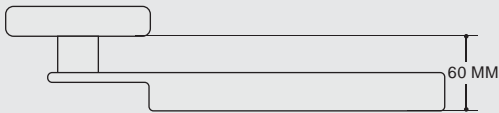

Couleurs disponibles / Available colours



Cette gamme résolument architecturale a été conçue en collaboration avec l'architecte Dplg Catherine ARDANT, qui a réhabilité l'Aéroport de Limoges BELLEGARDE en 2005, d'où le nom de la collection. Nous rendons hommage à cette brillante architecte qui nous a quitté prématurément en 2005.

«This totally architectural range was designed in collaboration with the Dplg architect, Catherine ARDANT, who in 2005 restored Limoges BELLEGARDE airport, hence the name of the collection. We pay tribute to this brilliant architect who left us prematurely in 2005.»

Porcelaine + inox



Inox BC



V7397 40 028

Inox clé I



V7383 40 028

Inox clé L



V7381 40 028

Inox BD



V7382 40 028

TOC TOC
Blanc - white

Design Wilfrid Delebecq



V0106 16 100
Plaque surf adhésive
Adhesive surf plate

Toc-Toc N
V3241 24 100V



V7380 40 028

Toc-Toc Inox
V3249 24 100V

Inox

Pour fenêtre - For window
Toc-Toc L



V5390 24 100

Toc-Toc L
V3240 24 100V



V7340 24 100

Rosace adhésive
Adhesive rose

Finition / Finish

L 020		N 019	
NM 022		INOX 028	

Carré / Square spindles

6	7	8

Fonction / Function

TB	Clé L	Clé I	BC	BD

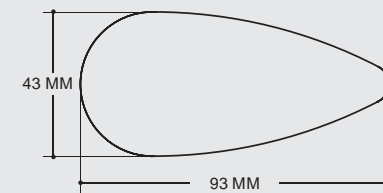
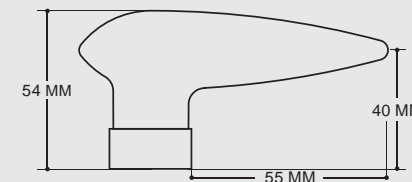

ø 50 mm
Sans trou de fixation
No fixing holes



Les références des béquilles mentionnées sont en C/7, merci de spécifier si vous souhaitez C/6 ou C/8
The handle article codes are with square 7, please specify if you want square 6 or 8

Nous déclinons toute responsabilité sur l'utilisation de ces produits sur des portes équipées de serrures nécessitant un relevage.

Finition / Finish



Carré / Square spindles



Fonction / Function

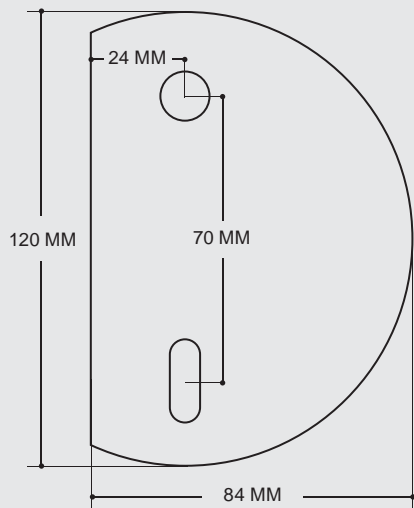

Les références des béquilles mentionnées sont en C/7, merci de spécifier si vous souhaitez C/6 ou C/8

The handle article codes are with square 7, please specify if you want square 6 or 8

Nous déclinons toute responsabilité sur l'utilisation de ces produits sur des portes équipées de serrures nécessitant un relevage.

Design Wilfrid Delebecq

TOC TOC
Blanc - white

Le designer Wilfrid Delebecq est guidé depuis 25 ans par un design simple, alliant modernité et facilité d'usage. Il a collaboré avec Roger Tallon et Philippe Stark. Par sa **simplicité**, la poignée « TOC TOC » s'inscrit dans la droite ligne des poignées traditionnelles en porcelaine ronde et ovoïde et se marie ainsi aux **styles d'intérieurs les plus divers**.

The designer Wilfrid Delebecq has been guided for the last 25 years by a simple style comprising user-friendly contemporary design.

He has collaborated with Roger Tallon and Philippe Stark.

Because of its simplicity « TOC TOC » handles has its place in traditional porcelain handles, either round or ovoid, and can be matched with various interior styles.



Toc-Toc L
V3240 24 100V



V0106 24 100G

Toc-Toc N
V3241 24 100V



V0106 24 100D

Plaque demi-lune adhésive
Adhesive half-moon plate

TOC TOC

Couleurs - colours

Design Wilfrid Delebecq



Toc-Toc L
V3240 24 402V

V0106 24 402

Plaque surf adhésive
Adhesive surf plate

Pour fenêtre - For window
Toc-Toc N
V5398 24 402



Toc-Toc Inox
V3249 24 402V



V7380 40 028

Inox

Toc-Toc N
V3241 24 402V



V7340 24 402

Rosace adhésive
Adhesive rose

Finition / Finish

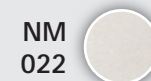

Carré / Square spindles



Fonction / Function



Couleurs disponibles Available colours



Voir schémas techniques page 23
See technical drawings page 23

Les références des béquilles mentionnées sont en C/7, merci de spécifier si vous souhaitez C/6 ou C/8

The handle article codes are with square 7, please specify if you want square 6 or 8

Nous déclinons toute responsabilité sur l'utilisation de ces produits sur des portes équipées de serrures nécessitant un relevage.

Finition / Finish



Carré / Square spindles



Fonction / Function

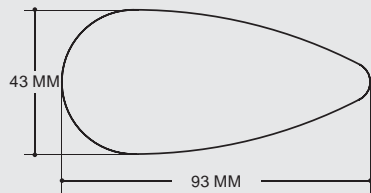
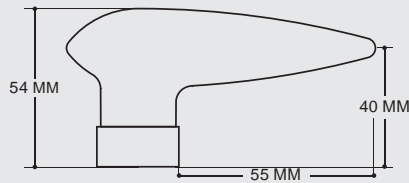

∅ 50 mm
Sans trou de fixation
No fixing holes



Les références des béquilles mentionnées sont en C/7, merci de spécifier si vous souhaitez C/6 ou C/8

The handle article codes are with square 7, please specify if you want square 6 or 8

Nous déclinons toute responsabilité sur l'utilisation de ces produits sur des portes équipées de serrures nécessitant un relevage.

Design Wilfrid Delebecq

TOC TOC
iris

Toc Toc iris gris - Grey
N
V3241 24 070-2NMV



V7340 24 100

Iris bleu - Blue



V3241 24 070-1NMV
+ V7340 24 100

Iris jaune - Yellow



V3241 24 070-3NMV
+ V7340 24 100

Iris marron - Brown



V3241 24 070-4NMV
+ V7340 24 100

Iris noir - Black



V3241 24 070-5NMV
+ V7340 24 100

Iris pivoine - Fuch-



V3241 24 070-6NMV
+ V7340 24 100

Iris rouge - Red



V3241 24 070-7NMV
+ V7340 24 100

Iris vert - Green



V3241 24 070-8NMV
+ V7340 24 100

Iris violet - Purple



V3241 24 070-9NMV
+ V7340 24 100

TOC TOC

Feuille de chêne - *oak leaf*

Design Wilfrid Delebecq



Toc-Toc L
V3240 24 071-1V

V0106 16 071-1

Plaque surf adhésive
Adhesive surf plate



Toc-Toc L
V3240 24 071-1V

V7340 24 100

Rosace adhésive
Adhesive rose



Pour fenêtre - *For window*
Toc-Toc L
V5390 24 071-1

Finition / Finish

- L 020   N 019
- NM 022 

Carré / Square spindles

-  6
-  7
-  8

Fonction / Function

-  TB
-  Clé L
-  Clé I
-  BC
-  BD

Décor disponible Available decor

Platine
Platinum

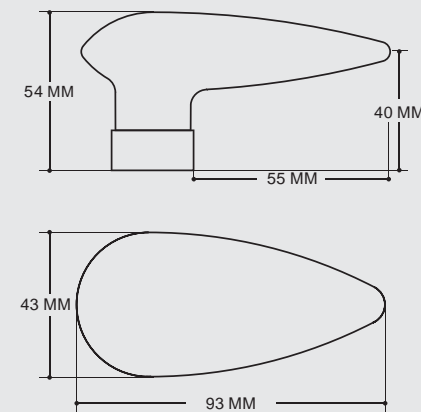



Les références des béquilles mentionnées sont en C/7, merci de spécifier si vous souhaitez C/6 ou C/8

The handle article codes are with square 7, please specify if you want square 6 or 8

Nous déclinons toute responsabilité sur l'utilisation de ces produits sur des portes équipées de serrures nécessitant un relevage.

Finition / Finish

L 020   N 019

NM 022 

Carré / Square spindles



Fonction / Function



Décor disponible Available decor

Or
Gold 

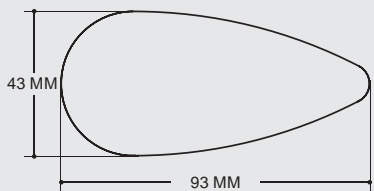
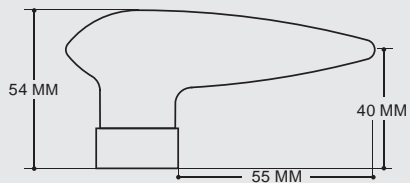

Les références des béquilles mentionnées sont en C/7, merci de spécifier si vous souhaitez C/6 ou C/8

The handle article codes are with square 7, please specify if you want square 6 or 8

Nous déclinons toute responsabilité sur l'utilisation de ces produits sur des portes équipées de serrures nécessitant un relevage.

Design Wilfrid Delebecq



Toc-Toc N
V3241 24 072-2V

V7340 24 100

Rosace adhésive
Adhesive rose



Pour fenêtre - For window
Toc-Toc N
V5398 24 072-2

TOC TOC Ginkgo - ginkgo leaf



Toc-Toc N
V3241 24 072-2V

V1101 16 072-2

Plaque surf adhésive
Adhesive surf plate

DELO LINDO

Béquille - *Leverhandles*

Design Delo Lindo

Croisillon



V6362 50 100CRV

Golf



V6362 50 100GOV

Cannelé



V6362 50 100CAV

Trèfle



V6362 50 100TRV

Aluminium Clé L



V7350 50 100

Aluminium Clé I



V7343 50 100

Aluminium BD



V7341 50 100

Aluminium TB



V7340 50 100

Aluminium BC
Bouton porcelaine
Porcelain knob



V6365 50 100

Finition / Finish

L
020



ALUMINIUM
ANODISÉ
*Anodised
aluminium*

Carré / Square spindles



Fonction / Function

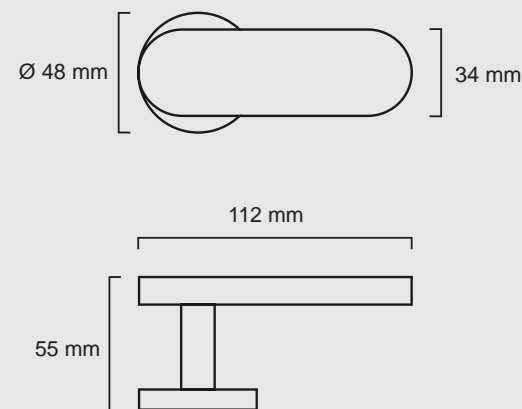

Les références des béquilles mentionnées sont en C/7, merci de spécifier si vous souhaitez C/6 ou C/8

The handle article codes are with square 7, please specify if you want square 6 or 8

Nous déclinons toute responsabilité sur l'utilisation de ces produits sur des portes équipées de serrures nécessitant un relevage.

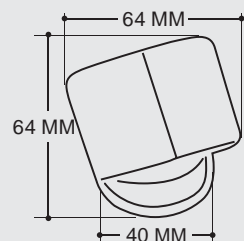
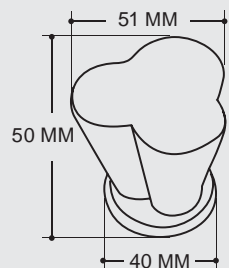
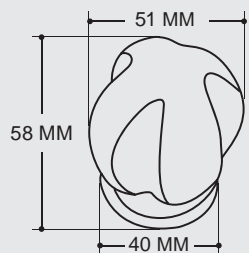

Les références des béquilles mentionnées sont en C/7, merci de spécifier si vous souhaitez C/6 ou C/8

The handle article codes are with square 7, please specify if you want square 6 or 8

Design Delo Lindo

DELO LINDO Bouton - Door knob

Laurent MATRAS et Fabien CAGANI se sont rencontrés sur les bancs de l'ENSAD à Paris. Ils créent, à la fin de leurs études, leur agence de création sous le nom de DELO LINDO qui signe tous leurs projets. Ils sont designers et architectes d'intérieur. Ils travaillent pour CINNA, Ligne ROSET, FERMOB...

Laurent Matras and Fabien Cagani met whilst studying at ENSAD in Paris. At the end of their course they opened their design agency, DELO LINDO, the mark of all their projects. They are interior designers and architects. They work for CINNA, ROSET range, FERMOB ...



Sphère



V3300 50 100SPV

Trèfle



V3300 50 100TRV

Cube



V3300 50 100CUV

Ces produits ont été sélectionnés par le Centre Georges Pompidou
Médaille d'or des Trophées du Design BATIMAT 97

Prix découverte Maison & Objet 97

Collection créée en collaboration avec le CRAFT (*Centre des Arts du Feu et de la Terre*)

*These products have been selected by the George Pompidou Centre and were created in collaboration with CRAFT.
Gold medal of Trophées du Design BATIMAT 97.
Innovation award Maison & Objet 97*



Chocolat - Chocolate
Pour fenêtre - For window
BM



V5387 11 436 + V0280 40 021

Noir - Black
Pour fenêtre - For window
N



V5398 11 402

Finition / Finish

L 020		N 019	
BM 021		FG 023	
RO 024		PVD 025	
NM 022		INOX 028	

Carré / Square spindles



Fonction / Function

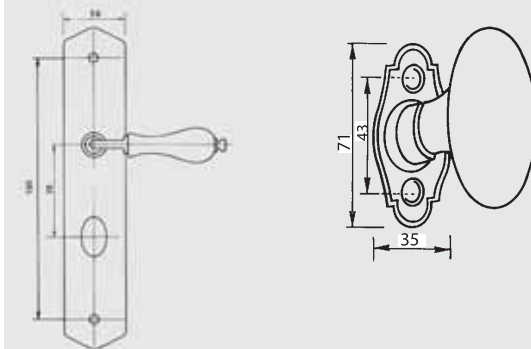









Existe également en plaque étroite 35 mm
Also exists in width 35 mm

Voir nuancier p. 4
See colours chart p. 4

N'oubliez pas de commander la visserie
Do not forget to order screws

Les références des béquilles mentionnées sont en C/7, merci de spécifier si vous souhaitez C/6 ou C/8
The handle article codes are with square 7, please specify if you want square 6 or 8

Finition / Finish

L 020		N 019	
BM 021		FG 023	
RO 024		PVD 025	
NM 022		INOX 028	

Carré / Square spindles



Fonction / Function

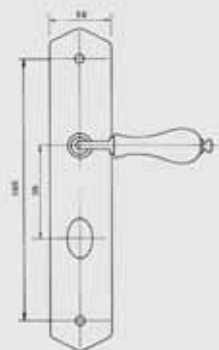

Existe également en plaque étroite 35 mm
Also exists in width 35 mm

Voir nuancier p. 4
See colours chart p. 4

N'oubliez pas de commander la visserie
Do not forget to order screws

Les références des béquilles mentionnées sont en C/7, merci de spécifier si vous souhaitez C/6 ou C/8
The handle article codes are with square 7, please specify if you want square 6 or 8

Bleu lavande
Lavender blue

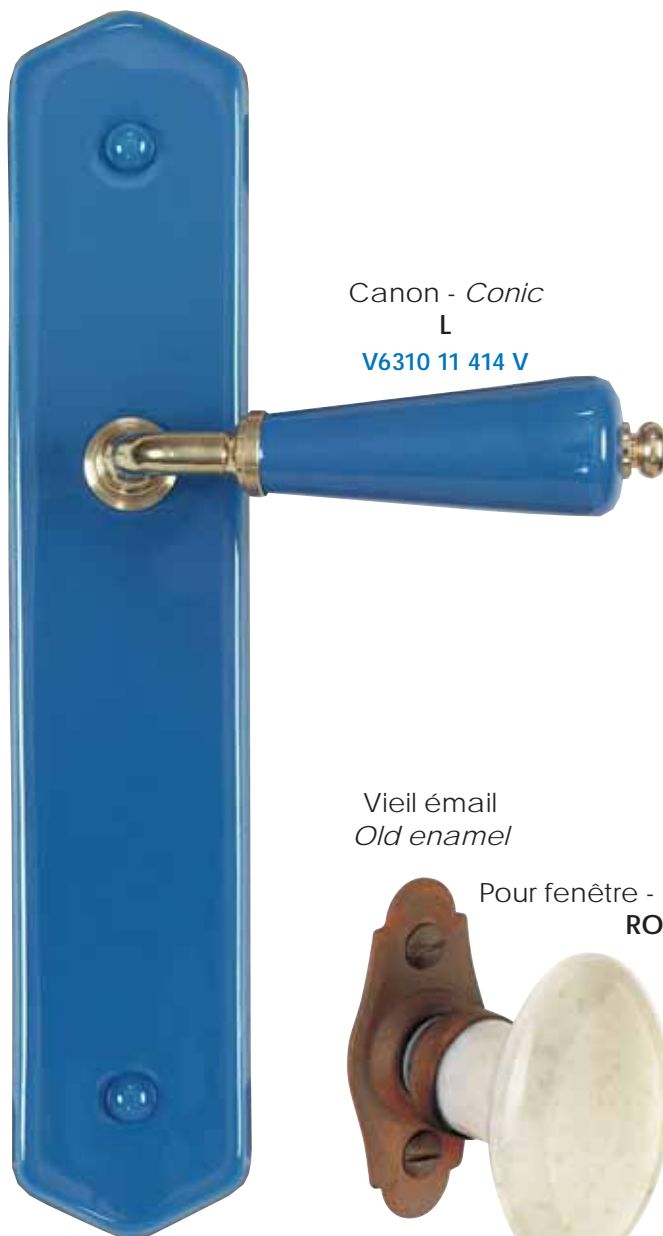

V0101 11 414

Canon - Conic
L
V6310 11 414 V

Vieil émail
Old enamel



V5387 11 430 + V0280 40 024

COULEURS - COLOURS

Jaune orangé
Orange yellow



V7340 11 420

Canon - Conic
L
V6340 11 420V



V7343 11 420

Jaune citron
Lemon yellow



V7340 11 411

Ovale - Oval
L
V3240 11 411V



V7350 11 411

ACIDULÉES - FLASHY COLOURS

Turquoise - *Turquoise blue*



Poire - *Pear*
L

V7340 11 423

V6340 11 423V



V7350 11 423

Rouge - *Red*



Canon - *Conic*
NM

V7340 11 421

V6311 11 421NMV

Vert anis - *Anise green*



Canon - *Conic*
NM

V7340 11 428

V6311 11 428NMV

Fuchsia

Pour fenêtre - *For window*
L



V5387 11 426

Orange

Ovale - *Oval*
L



V7340 11 427

V3240 11 427V



V7350 11 427

Finition / Finish

L
020



BM
021



RO
024



NM
022



N
019



FG
023



PVD
025



INOX
028

Carré / Square spindles



6



7



8

Fonction / Function



TB



Clé L



Clé I



BC



BD

Couleurs disponibles Available colours

423



421



428



426









427

N'oubliez pas de commander la visserie
Do not forget to order screws

Les références des béquilles mentionnées sont en C/7, merci de spécifier si vous souhaitez C/6 ou C/8

The handle article codes are with square 7, please specify if you want square 6 or 8

Finition / Finish

L 020		N 019	
BM 021		FG 023	
RO 024		PVD 025	
NM 022		INOX 028	

Carré / Square spindles



Fonction / Function



Couleurs disponibles Available colours

435		452	
403		436	
438		407	
437			

N'oubliez pas de commander la visserie
Do not forget to order screws

Les références des béquilles mentionnées sont en C/7, merci de spécifier si vous souhaitez C/6 ou C/8

The handle article codes are with square 7, please specify if you want square 6 or 8

Taupe - Mole brown



Canon - Conic
NM
V6311 11 438NMV

V7340 11 438

Coquille d'oeuf - Eggshell
Ovale - Oval
NM

V3241 11 407NMV



V7340 11 407

Violet - Purple
Pour fenêtre - For window
NM

V5398 11 437NM



NOIR & BLANC - BLACK & WHITE



V0106 11 050

Arabesque noire - Black
V6311 11 050V



Tendance PP1
V6311 11 041V

V7340 40 019
Rosace nickelée - Nickeled rose



Arabesque noire - Black
V6311 11 050V

V7340 40 019
Rosace nickelée - Nickeled rose



Tendance PP1
V3241 11 041V

V7340 40 019
Rosace nickelée
Nickeled rose



V7340 40 019
Rosace nickelée
Nickeled rose

Finition / Finish

L
020



N
019



NM
022



Carré / Square spindles



6



7



8

Fonction / Function



TB



Clé L



Clé I



BC



BD

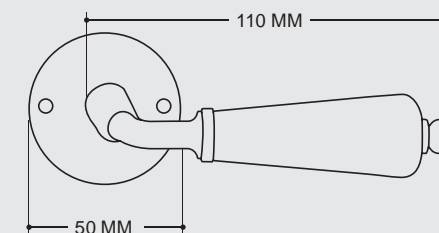
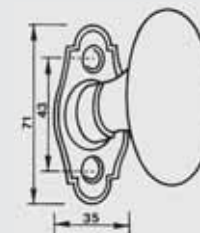

N'oubliez pas de commander la visserie
Do not forget to order screws

Les références des béquilles mentionnées sont en C/7, merci de spécifier si vous souhaitez C/6 ou C/8

The handle article codes are with square 7, please specify if you want square 6 or 8

Finition / Finish



Carré / Square spindles



Fonction / Function

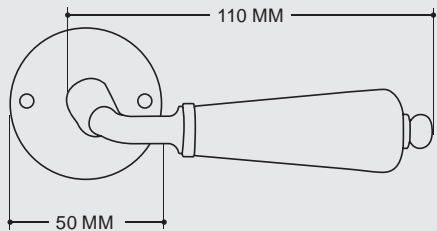
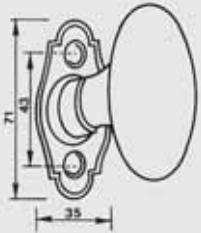

N'oubliez pas de commander la visserie
Do not forget to order screws

Les références des béquilles mentionnées sont en C/7, merci de spécifier si vous souhaitez C/6 ou C/8

The handle article codes are with square 7, please specify if you want square 6 or 8



Toile de Jouy noire - *Liberty print black*
V6311 11 045-2V

V7340 11 045-2



Toile de Jouy bleue - *Liberty print blue*
V6310 11 045-1V

V7340 11 045-1



Toile de Jouy rouge - *Liberty print red*
V6310 11 045-3V

V7340 11 045-3



Toile de Jouy noire - *Liberty print black*
V7350 11 045-2

V7340 11 045-2



DÉCORÉE - DECOR

Semis fleurs bleues - Blue pattern



Finition / Finish

L 020		N 019	
BM 021		FG 023	
RO 024		PVD 025	
NM 022		INOX 028	

Carré / Square spindles



Fonction / Function



Décor disponibles / Available decors

Flours multicolores 184		Semis fleurs bleues 185	
Saxony 155		Verity 126	
Lavande 180		Flours roses 123-2	
Poppies 178		Flours bleues 123-1	
Quiberon 159-2		Safari 160	

N'oubliez pas de commander la visserie
Do not forget to order screws

Les références des béquilles mentionnées sont en C/7, merci de spécifier si vous souhaitez C/6 ou C/8
The handle article codes are with square 7, please specify if you want square 6 or 8

Finition / Finish

L 020		N 019	
BM 021		FG 023	
RO 024		PVD 025	
NM 022		INOX 028	

Carré / Square spindles



Fonction / Function



Décors disponibles / Available decors

Flours multicolores 184		Semis Flours bleues 185	
Saxony 155		Verity 126	
Lavande 180		Flours roses 123-2	
Poppies 178		Flours bleues 123-1	
Quiberon 159-2		Safari 160	

N'oubliez pas de commander la visserie
Do not forget to order screws

Les références des béquilles mentionnées sont en C/7, merci de spécifier si vous souhaitez C/6 ou C/8
The handle article codes are with square 7, please specify if you want square 6 or 8



Canon - Conic
L
V6310 11 184V

V0101 11 184

Pour fenêtre - For window
L
V5387 11 184



DÉCORÉE - DECOR

Flours multicolores - multicoloured flowers



V6310 11 184V

V7340 11 184



Rosace condamnation
Lock knob rose
L
V6365 11 184

Ovale - Oval
L
V3240 11 184V



V7340 11 184



Rosace décondamnation
Safety rose
V7341 11 184

DÉCORÉE - DECOR

Blanc + sépia - White + sepia



Canon - Conic
L
V6310 11 505V

V0106 11 505



Poire - Pear
RO
V6325 11 505V

V7340 11 505



V7350 11 505



Ovale - Oval
RO
V3016 11 505V

V7340 11 505



V7350 11 505

Finition / Finish



Carré / Square spindles



Fonction / Function



Couleurs disponibles Available colours



N'oubliez pas de commander la visserie
Do not forget to order screws

Les références des béquilles mentionnées sont en C/7, merci de spécifier si vous souhaitez C/6 ou C/8
The handle article codes are with square 7, please specify if you want square 6 or 8

Nous attirons votre attention sur la fragilité de ce produit en raison du craquelé

Finition / Finish



Carré / Square spindles



Fonction / Function



Couleurs disponibles Available colours



N'oubliez pas de commander la visserie
Do not forget to order screws

Les références des béquilles mentionnées sont en C/7, merci de spécifier si vous souhaitez C/6 ou C/8
The handle article codes are with square 7, please specify if you want square 6 or 8

Turquoise - *Turquoise blue*



Vert anis - *Anise green*



Bleu de four - *Cobalt blue*



Rosace condamnation
Lock knob rose
L



TERRA COTTA

Terra cotta émaillé
Enamelled terra cotta



Poire - *Pear*
L
V6340 11 005V

Pour fenêtre - *For window*
L
V5387 11 005

V0110 11 005

Terra cotta brut
Unenamelled terra cotta



Poire - *Pear*
L
V6340 11 007V

Pour fenêtre - *For window*
L
V5387 11 007

V0106 11 007

Finition / Finish

L
020 

Carré / Square spindles

  
6 7 8

Fonction / Function

    
TB Clé L Clé I BC BD

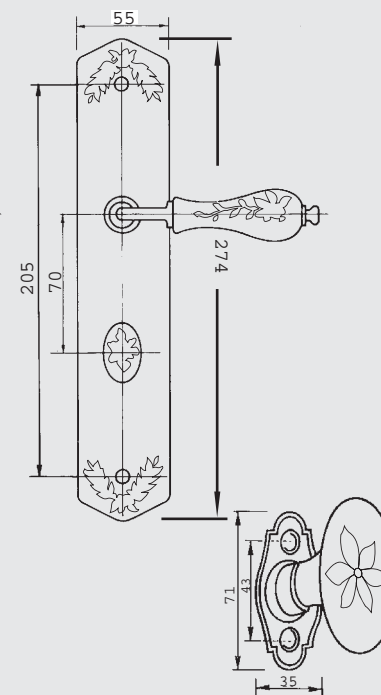

N'oubliez pas de commander la visserie
Do not forget to order screws

Les références des béquilles mentionnées sont en C/7, merci de spécifier si vous souhaitez C/6 ou C/8
The handle article codes are with square 7, please specify if you want square 6 or 8

Nous déclinons toute responsabilité sur l'utilisation de ces produits sur des portes équipées de serrures nécessitant un relevage.

Finition / Finish



Carré / Square spindles



Fonction / Function

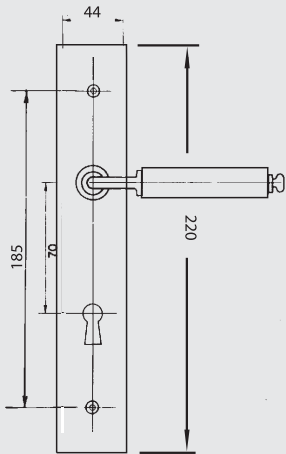

V0106 11 162

Cylindrique - Cylinder handle
L

V6304 11 162V



Pour fenêtre - For window
L

V5390 13 162



N'oubliez pas de commander la visserie
Do not forget to order screws

Les références des béquilles mentionnées sont en C/7, merci de spécifier si vous souhaitez C/6 ou C/8
The handle article codes are with square 7, please specify if you want square 6 or 8

SURF

Pamplemousse - *Grapefruit yellow*
L



V6310 16 434V

V0106 16 434

Bleu opale - *Opal blue*
Pour fenêtre - *For window*
L



V5390 16 432

L
020



N
019

Carré / Square spindles



6



7



8

Fonction / Function



TB



Clé L



Clé I



BC



BD

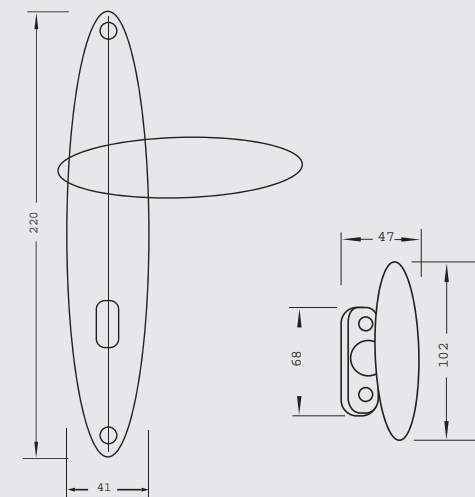

Couleurs disponibles Available colours

100



434

433











432

N'oubliez pas de commander la visserie
Do not forget to order screws

Les références des béquilles mentionnées sont en C/7, merci de spécifier si vous souhaitez C/6 ou C/8
The handle article codes are with square 7, please specify if you want square 6 or 8

Nous déclinons toute responsabilité sur l'utilisation de ces produits sur des portes équipées de serrures nécessitant un relevage.

Finition / Finish

- L 020   N 019
- BM 021   FG 023
- RO 024   NS 029
- LS 027   INOX 028







Carré / Square spindles

-  6
-  7
-  8

Fonction / Function

-  TB
-  Clé L
-  Clé I
-  BC
-  BD

Couleurs disponibles / Available colours

- 426E  Essuyé fuchsia
- 423E  Essuyé turquoise
- 100  Blanc
- 438  Taupe
- 436E  Essuyé chocolat
- 420E  Essuyé jauné-orange
- 429  Blanc cassé

N'oubliez pas de commander la visserie
Do not forget to order screws

Les références des béquilles mentionnées sont en C/7, merci de spécifier si vous souhaitez C/6 ou C/8
The handle article codes are with square 7, please specify if you want square 6 or 8



Blanc - White
NS
V6340 25 100V
+ Majo Nickel satiné V0070 40 029

V7340 40 029



Blanc cassé - Off white
BM
V6340 25 429V
+ Majo Bronze médaille V0070 40 021

V7340 40 021



Essuyé chocolat - Wiped chocolate
BM
V6340 25 436E
+ Majo Bronze médaille V0070 40 021

V0522 40 021



Essuyé jaune - Wiped yellow
RO
V6340 25 420E
+ Majo Rouille V0070 40 024

V7340 40 024



V0525 40 021



V7350 40 024

Le coude Luxe n'est disponible que sur la béquille MANDALIS
The Luxe bend is only available on Mandalis

MANDARINE

Blanc filet or - *White gold line*
L



V6340 18 170V

Peint main - hand painted

V0101 18 170

Blanc - *White*
L



V6340 18 100V

V0106 18 100

Finition / Finish

L
020



N
019

Carré / Square spindles



6



7



8

Fonction / Function



TB



Clé L



Clé I



BC



BD

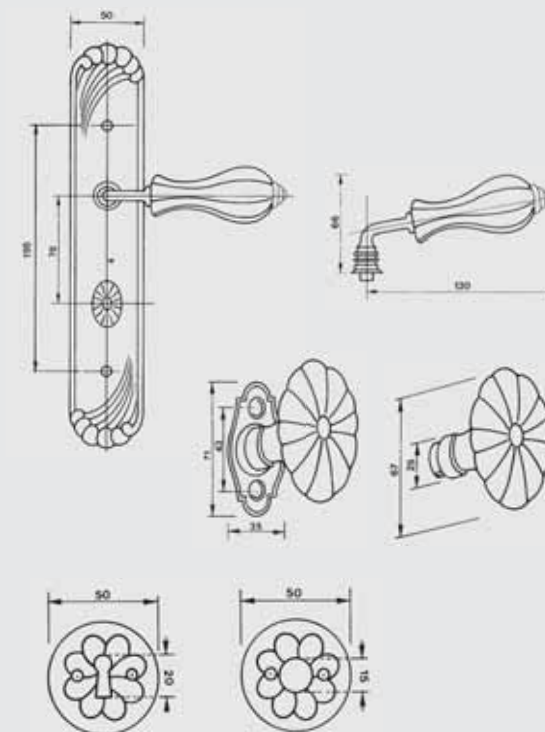

Existe en filets platine

N'oubliez pas de commander la visserie
Do not forget to order screws

Les références des béquilles mentionnées sont en C/7, merci de spécifier si vous souhaitez C/6 ou C/8
The handle article codes are with square 7, please specify if you want square 6 or 8

Finition / Finish

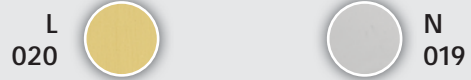

Carré / Square spindles



Fonction / Function

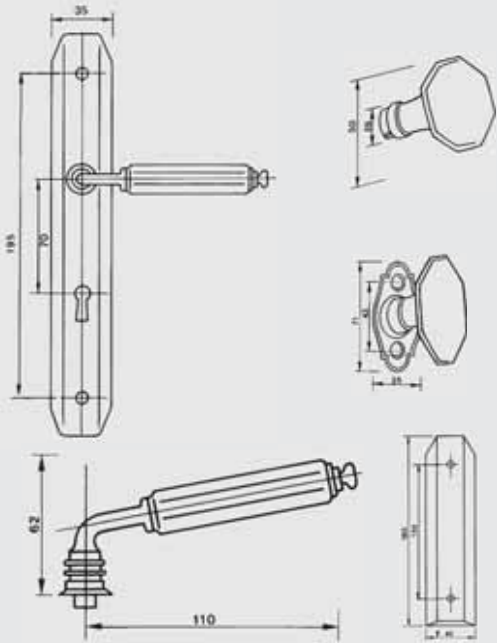

N'oubliez pas de commander la visserie
 Do not forget to order screws
 Les références des béquilles mentionnées sont en C/7, merci de spécifier si vous souhaitez C/6 ou C/8
 The handle article codes are with square 7, please specify if you want square 6 or 8

Blanc - White
N



V0101 13 100

Blanc bande platine
White platinum stripe
N



V0101 13 171

Nous déclinons toute responsabilité sur l'utilisation de ces produits sur des portes équipées de serrures nécessitant un relevage.

STYLE

Blanc - White
L



V0101 14 100

Blanc filet or - White gold line
L



V1100 14 140

Blanc jaspe bleu - White blue jasper
N



V0116 14 107

Finition / Finish

L
020



N
019

Carré / Square spindles



Fonction / Function

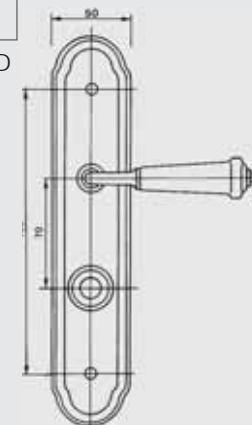
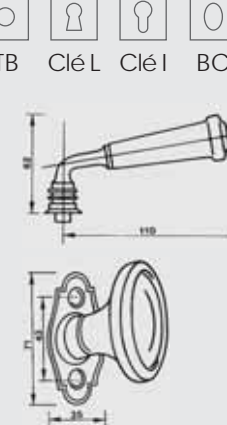

Décor disponibles / Available decors

Fruits
102



Jaspe vert
105

Feuille vigne
101



Jaspe rose
108

Feuille lierre
109



Jaspe jaune
106

Winchester
bleu
153



Jaspe bleu
107

Winchester
rose
154



N'oubliez pas de commander la visserie
Do not forget to order screws

Les références des béquilles mentionnées sont en C/7, merci de spécifier si vous souhaitez C/6 ou C/8
The handle article codes are with square 7, please specify if you want square 6 or 8

Finition / Finish

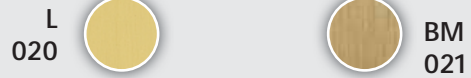

Carré / Square spindles



Fonction / Function



Ce bouton ne peut s'adapter que sur des portes de demeures ou d'immeubles classés monuments historiques. Le bouton peut ainsi être manipulé des deux mains et utilisé de l'un ou l'autre côté de la porte.

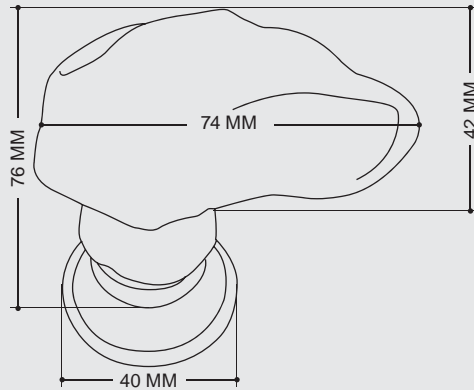

Les références des béquilles mentionnées sont en C/7, merci de spécifier si vous souhaitez C/6 ou C/8

The handle article codes are with square 7, please specify if you want square 6 or 8

Ce modèle a été créé vers 1897 par **Hector GUIMARD** Maître de l'**Art Nouveau** à qui nous devons les bouches de Métropolitain à Paris. La forme mouvementée de ce bouton de porte est le résultat d'un processus de création inédit. Hector Guimard l'a modelé en pressant une motte de terre glaise dans sa main gauche lui donnant sa forme générale, puis dans sa main droite en y imprimant le pouce et l'index.



This model was created around 1897 by Hector Guimard. Master in art nouveau, we owe the Paris Metro entrances to him. The undulating shape of this door knob is the result of an original process by HG : he clutched a lump of clay first in his left hand, giving it its overall shape, then in the right, leaving his thumb and index finger prints in.

Blanc cassé - Off white
L

V3240 48 429V



Cuvette moletée à l'ancienne
Old style brass base

V0522 40 020

Rosace festonnée laiton
Brass old style rose

LES POIGNÉES DE QUIMPER

Par **BHENRIOT** pour Morigous
FAÏENCIER DEPUIS 1690

Rosace carrée - *Square rose*

V7340 26 120 - 1

V6310 26 120-1

V7340 26 120 - 1

V6310 26 120-2

V7340 26 120 - 3

V6310 26 120-3

V7340 26 120 - 3

V6310 26 120-4

Finition / Finish

L
020



N
019



Carré / Square spindles



Fonction / Function

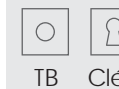

TB Clé L

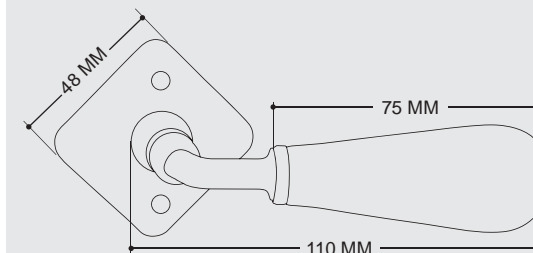

Les références des béquilles mentionnées sont en C/7, merci de spécifier si vous souhaitez C/6 ou C/8
 The handle article codes are with square 7, please specify if you want square 6 or 8

N'oubliez pas de commander la visserie
 Do not forget to order screws

Finition / Finish

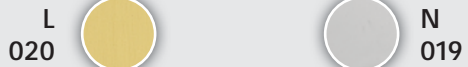

Carré / Square spindles



Fonction / Function

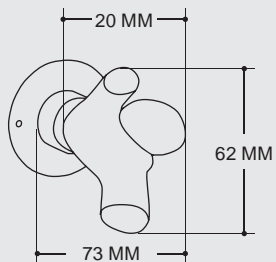
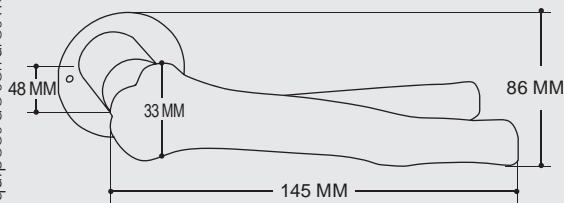

Couleurs disponibles / Available colours



Les références des béquilles mentionnées sont en C/7, merci de spécifier si vous souhaitez C/6 ou C/8
 The handle article codes are with square 7, please specify if you want square 6 or 8

N'oubliez pas de commander la visserie
 Do not forget to order screws

Nous déclinons toute responsabilité sur l'utilisation de ces produits sur des portes équipées de serrures nécessitant un relevage.



V7340 40 020



V7340 40 020



V7340 40 020



V7340 40 019

DORIQUE

Design Wilfrid Delebecq

Ces poignées permettent à la porcelaine d'entrer dans le monde contemporain avec une ligne totalement épurée tout en gardant une référence à des formes classiques.

These two new handles enable the porcelain to match with the contemporary world because of their totally pure line which still refers to more classical shapes.



FUSAIN



Finition / Finish

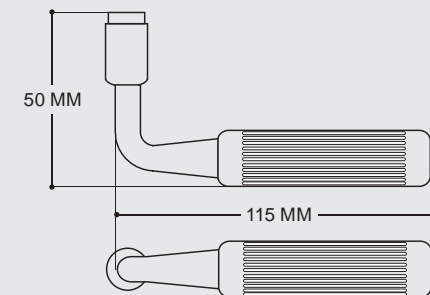
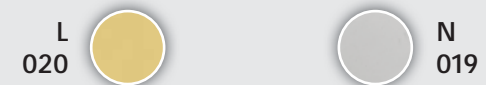

Carré / Square spindles



Fonction / Function

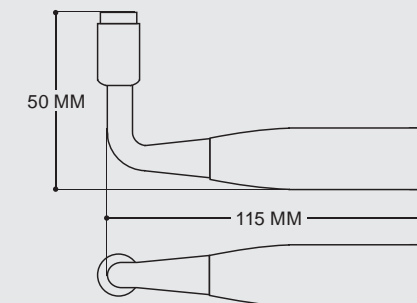

Finition / Finish

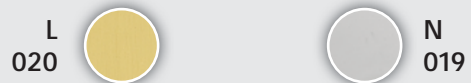

Carré / Square spindles



Fonction / Function

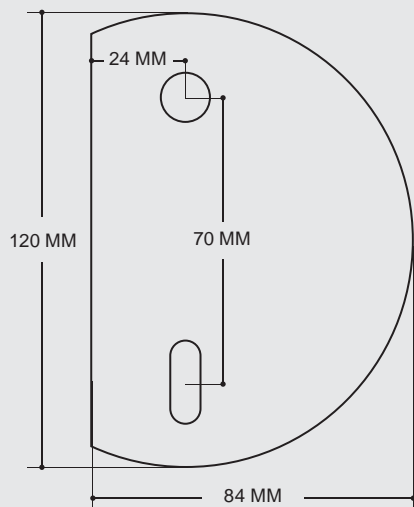
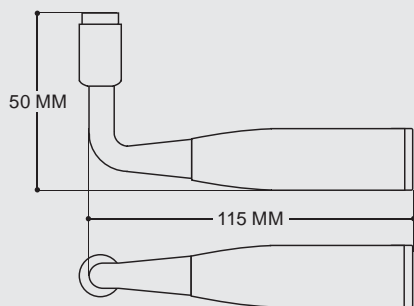





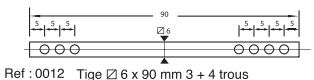
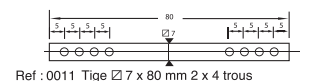
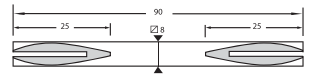
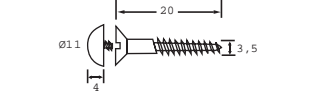
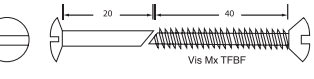

La pureté de la ligne de la poignée Fusain est accentuée par la plaque « demi-lune » adhésive.
 The pure line of FUSAIN Handle is emphasized by the simplicity of the adhesive "half moon" push plate.

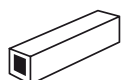

ACCESSOIRES PORTES ET FENÊTRES - ACCESSORIES FOR DOOR AND WINDOWS

Référence	Désignation	Croquis
V001240019	Tige C/6 x 90 mm 4+3 trous	
V001340019	Tige C/7 x 80 mm 4+4 trous	
V000440019	Tige C/6 x 90 mm fraisée fendue	
V002740019	Tige C/7 x 90 mm fraisée fendue	
V001740019C	Vis avec cache tête porcelaine blanche à coller	
V001740019V	Vis avec cache tête porcelaine blanche à visser	
V005540019	Vis avec cache tête porcelaine couleur à visser	
V000140020	Vis relieuse 4 x 45/7 x 22 laiton	
V000140019	Vis relieuse 4 x 45/7 x 22 nickelée	
V000140021	Vis relieuse 4 x 45/7 x 22 bronze médaille	
V000140023	Vis relieuse 4 x 45/7 x 22 fer gris	
V000140024	Vis relieuse 4 x 45/7 x 22 rouille	
V000140022	Vis relieuse 4 x 45/7 x 22 nickelée mat	

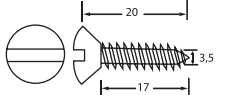
Référence	Désignation	Croquis
V002140019	Fourreau plastique C/6 à C/7 lg 26 mm	
V003740019	Circlips pour montage à griffe	
V027740019	Rondelle plastique 20x14 mm	14 mm  20 mm
V001640019	Vis pointeau	 Existe en longueur 5, 6, 10
V006440019	Clé alène 6 pans	
V000840019	Portée plastique C/6	
V000940019	Portée plastique C/7	
V002940019	Vis TFBF 3,5x20 laitonée	
V003340019	Vis TFBF 3,5x20 nickelée	
V003340021	Vis TFBF 3,5x20 bronze médaille	
V003340023	Vis TFBF 3,5x20 fer gris	
V003340024	Vis TFBF 3,5x20 rouille	
V003340028	Vis TFBF 3,5x20 inox brossé	
V003340022	Vis TFBF 3,5x20 nickelé mat	

Quincaillerie
d'ameublement
Building decorative hardware

BLANC - WHITE

Bouton ø 30 mm - Existe en ø 25 & 35 mm

Cupboard knob ø 30 mm - Exists in ø 25 & 35 mm



Bouton ovale ± 32 mm

Oval cupboard knob ± 32 mm



Bouton ovale ± 42 mm

Oval cupboard knob ± 42 mm



Bouton ø 30 mm & ovale ± 32 mm - Existe en ø 25 mm et 35 mm

Cupboard knob ø 30 mm & oval ± 32 mm - Exists in ø 25 & 35 mm



Bouton ø 30 mm & ovale ± 32 mm - Existe en ø 25 mm et 35 mm

Cupboard knob ø 30 mm & oval ± 32 mm - Exists in ø 25 & 35 mm



Finition / Finish

L 020		N 019	
BM 021		FG 023	
RO 024		PVD 025	
NM 022		INOX 028	

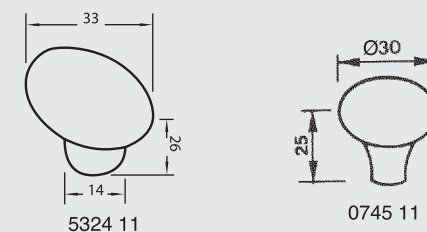
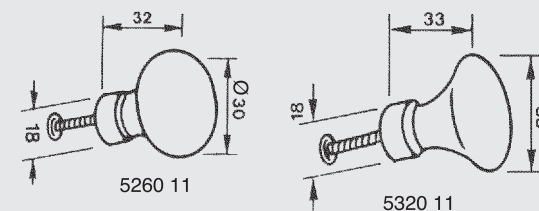

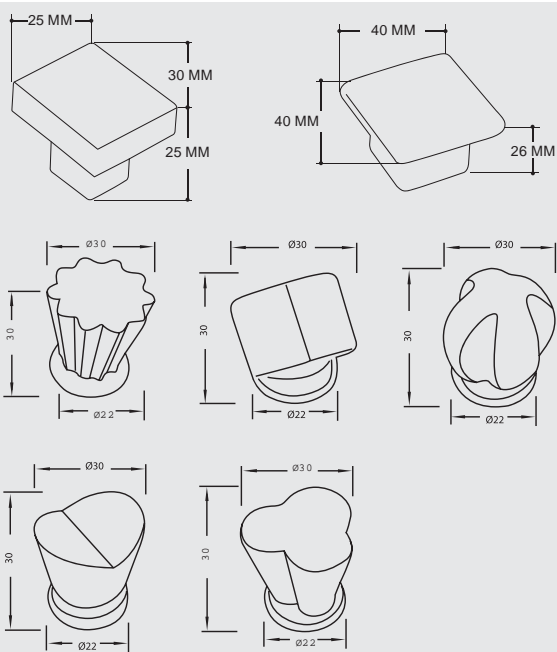

Couleurs disponibles Sucre & carré
Available colours Sugar & square



SUCRE - SUGAR

30 x 25 mm



0698 11 436



0698 11 427



0698 11 421

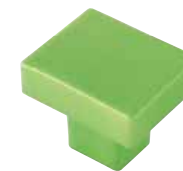

0698 11 428



0698 11 100

Médaille d'or des Trophées du Design Batimat 97
Prix Découverte Maison et Objet 97

Gold medal of Trophées du Design BATIMAT 97.
Innovation award Maison & Objet 97

DELO LINDO BLANC - WHITE

Existe en 432, 433 & 434
Exists in 432, 433 & 434



0745 50 100CA



0745 50 100CU



0745 50 100SP



0745 50 100TE



0745 50 100TR

CARRÉ - SQUARE

40 x 40 mm



0691 21 437



0691 21 426



0691 21 452



0691 21 427



0691 21 421



0691 21 428



0691 21 100



0691 21 122



0691 21 179-1



0691 21 179-2



0691 21 179-3



0691 21 179-4

Bois Wengue



0691 85 004

BLANC FORME - SHAPE WHITE



Finition / Finish

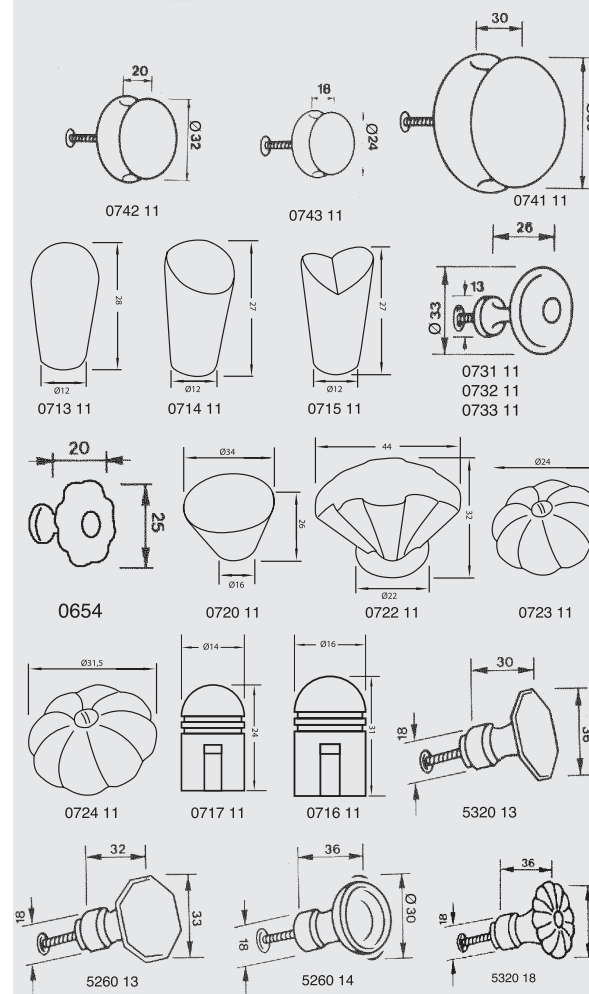

Finition / Finish

L 020		N 019	
BM 021		FG 023	
RO 024		PVD 025	
NM 022		INOX 028	

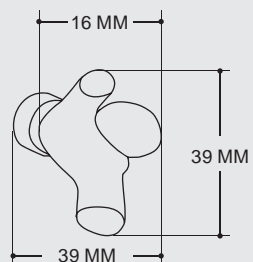
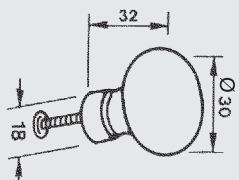

COULEURS / COLOURS

Bouton ø 30 mm - Existe en ø 25 & 35 mm & ovale ± 32 mm
Cupboard knob ø 30 mm - Exists in ø 25 & 35 mm & oval ± 32 mm



CRISTOBAL



SURF

Poignées EA 64 mm - Handle EA 64 mm



0246 16 434 0246 16 432 0246 16 426 0246 16 433 0246 16 427 0246 16 421 0246 16 100

Boutons ø 35 mm - Cupboard knob ø 35 mm



0706 16 434 0706 16 432 0706 16 426 0706 16 433 0706 16 427 0706 16 421 0706 16 100

DUO ø 30 MM



5260 23 200 5162 23 605 5162 23 499 5161 23 100 5160 23 600

EMAIL DE LIMOGES CHAMPLEVÉ

Merci d'indiquer le texte choisi
Please precise text



7340 40 415
+ 5260 11 429

7340 40 423
+ 5260 11 429

7340 40 421
+ 5260 11 429

7340 40 428
+ 5260 11 429

Couleurs disponibles SURF Available colours SURF



EA 64 mm

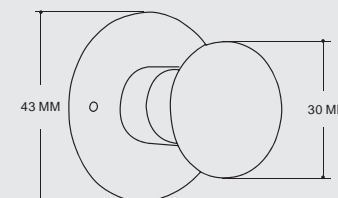
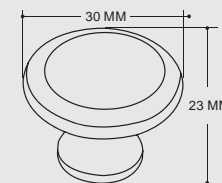
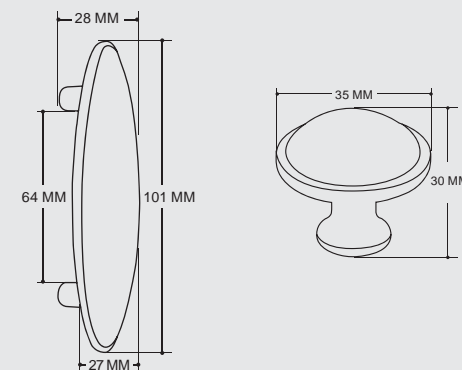

Finition / Finish

L 020		N 019	
BM 021		FG 023	
RO 024		PVD 025	
NM 022		INOX 028	

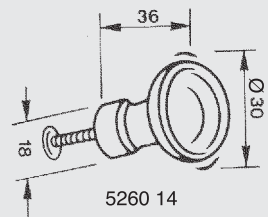
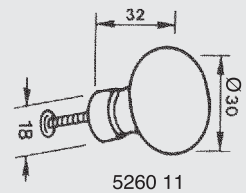
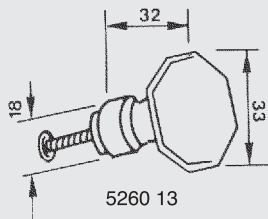

OCTOMA

Boutons ø 30 mm - Cupboard knob ø 30 mm



FILET COULEUR

Bouton ø 30 mm - Existe en ø 35 mm
Cupboard knob ø 30 mm - Exists in ø 35 mm



JASPE COULEUR

Boutons ø 30 mm - Cupboard knob ø 30 mm



JASPE DÉCOR

Boutons ø 30 mm - Cupboard knob ø 30 mm



HERBIER (Motifs mélangés - Assorted)

Bouton ø 30 mm - Existe en ø 35 mm
Cupboard knob ø 30 mm - Exists in ø 35 mm



5260 11 120-1



5360 11 120-2



5260 11 120-3



5260 11 120-4



5260 11 120-5



5260 11 120-6

FRUITS

Bouton ø 30 mm - Existe en ø 35 mm
Cupboard knob ø 30 mm - Exists in ø 35 mm



5260 11 008-1



5260 11 008-2



5260 11 008-3



5260 11 008-4



5260 11 008-5



5260 11 008-6

ENFANTS - CHILDREN

Bouton ø 30 mm - Existe en ø 35 mm
Cupboard knob ø 30 mm - Exists in ø 35 mm

Réf. 064 série de 4 motifs
Assorted



5260 11 010



5260 11 066-1



5260 11 066-2



5260 11 066-3



5260 11 064-1



5260 11 064-2



5260 11 016



5260 11 066-4



5260 11 066-5



5260 11 066-7



5260 11 064-3



5260 11 064-4



0745 11 063-1



0745 11 063-2



0745 11 063-3



0745 11 063-5

IKEBANA

Bouton ø 35 mm
Cupboard knob ø 35 mm



5270 11 113



5270 11 114



5270 11 115



5270 11 116

Finition / Finish

L
020



BM
021



RO
024



NM
022



N
019



FG
023



PVD
025



INOX
028

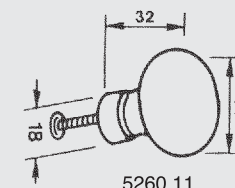

5260 11

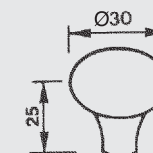

0745 11

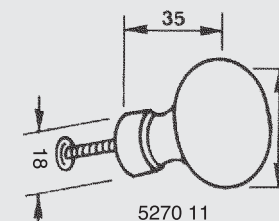

5270 11

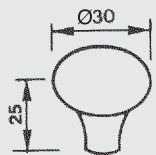

0745 11



0745 11 059-1



0745 11 059-2



0745 11 059-3



0745 11 059-4



0745 11 059-5



0745 11 059-6



0745 11 059-7

POP

ARABESQUE (Motifs mélangés - Assorted)



0742 11 050-1



0742 11 050-2



0742 11 050-3



0742 11 051-1



0742 11 051-2



0742 11 051-3

TOILE DE JOUY - LIBERTY PRINT

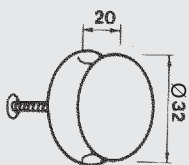

0742 11



0742 11 045-1



0742 11 045-2



0742 11 045-3



0742 11 052

WDG

TERRA COTTA

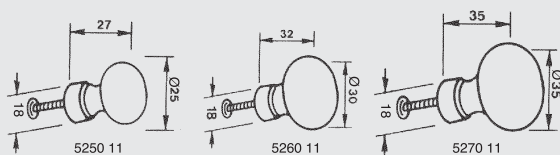

0742 11 005



0742 11 007



ø 25
5250 11 158



ø 30
5260 11 158



ø 35
5270 11 158

VAGUES - WAVES

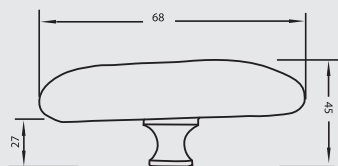

5000 11



5000 11 100



5000 11 159-1



5000 11 159-2



5000 11 159-3



5000 11 159-4

GALETS - PEBBLES

FLEURS - FLOWERS

Bouton ø 30 mm - Existe en ø 25 & 35 mm
Cupboard knob ø 30 mm - Exists in ø 25 & 35 mm



5260 11 164



5260 11 126



5260 11 124



5260 11 122



5260 11 155



5260 11 122-2



5260 11 122-1



5260 11 156



5261 11 123-1



5260 11 123-2



5260 11 161



5260 11 153



5261 11 159-2



5260 11 180



5260 11 120R



5260 21 220



5260 11 178



Bouton avec rosace
Knob with rose
0748 21 221

Bouton seul - Knob only
0748 21 220

Finition / Finish

L 020		N 019	
BM 021		FG 023	
RO 024		PVD 025	
NM 022		INOX 028	

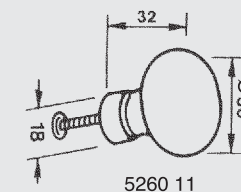

SAFARI



5160 11 160-1



5160 11 160-2



5160 11 160-3

SMILEY



5261 11 058-1NM



5261 11 058-2NM



5261 11 058-3NM

Finition / Finish

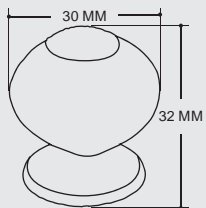
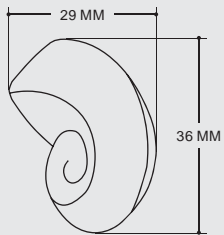
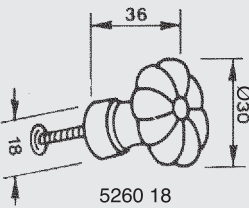
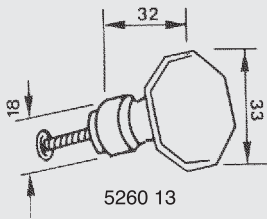
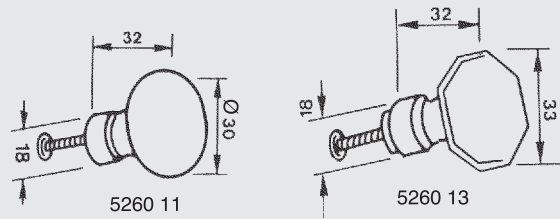
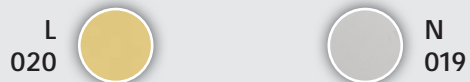

UNI Filet or - Platine
Gold - platinum line

Bouton ø 30 mm & ovale ± 32 mm - Cupboard knob ø 30 mm & oval ± 32 mm



5260 11 140



5261 11 141



5260 13 170



5261 13 171

OCTOMA Bande or - Platine
Gold - platinum stripe

MANDARINE Fils or - Platine
Gold - platinum line



5260 18 170



5261 18 175

CHÊNE Or - Platine
Gold - Platinum

GINKGO Or - Platine
Gold - Platinum

Bouton ø 35 mm - Cupboard knob ø 35 mm



5270 11 071-1



5271 11 071-2



5260 11 072-1



5261 11 072-2

SHELL



0746 47 800



0746 47 100

OCTOMA Loupe d'orme
Elm burl

Bouton ø 30 mm & ovale ± 32 mm
Cupboard knob ø 30 mm & oval ± 32 mm



5260 13 173

PEINT MAIN - HAND PAINTED

Bouton ø 30 mm uniquement
Cupboard knob ø 30 mm only



5260 18 173



5260 15 170



5261 18 172



5260 15 171

SHÉRAZADE

Bouton ø 30 mm uniquement
Cupboard knob ø 30 mm only



5156 21 427S



5156 21 421S



5156 21 422S



5156 21 419S



5156 21 423S



5156 21 411S



5156 21 426S

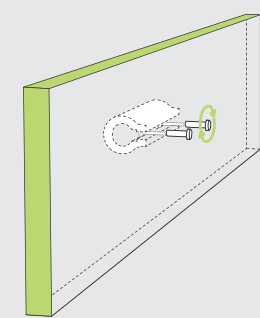
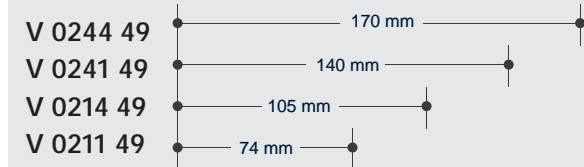
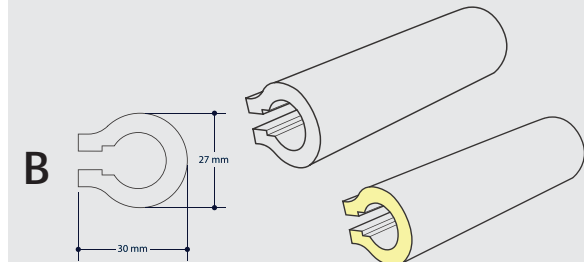
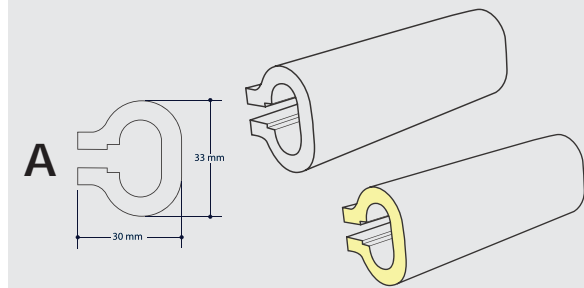

Couleurs disponibles
Available colours

- | | | | |
|-----|--|-----|--|
| 100 | | 427 | |
| 428 | | 423 | |

ENTRÉE DE CLÉ POUR MEUBLE - ESCUTCHEONS

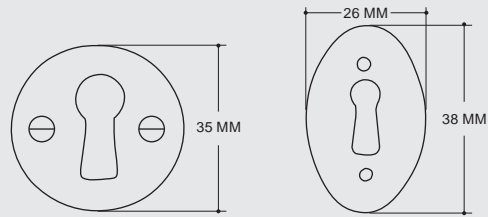

7339 11 100



7338 11 100



7337 11 100



7336 11 100

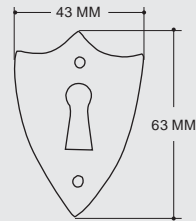
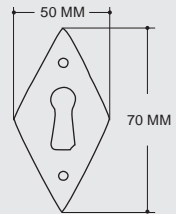

POIGNÉE COQUILLE - SHELL HANDLE



0259 21 100

POIGNÉE ENCHAPPE



9982 11 100

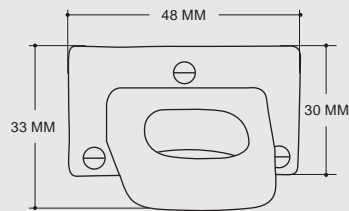
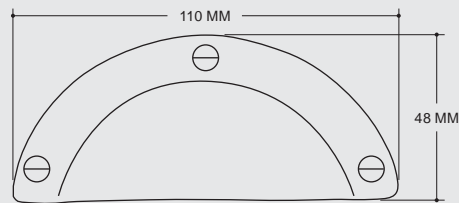

PENDANTS



7322 21 100



7318 21 100



7319 21 100

POIGNÉES DE MEUBLES - FURNITURE HANDLE

Bleu de four - *Cobalt blue*
FG

EA 192 MM



7313 11 419

Blanc - *White*
RO

EA 160 MM



7324 11 100

Blanc - *White*
FG

EA 128 MM

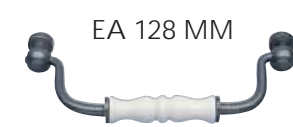

7315 11 100

NOTES

Pour tout renseignement complémentaire, notre Service Commercial se tient à votre disposition, n'hésitez pas à nous demander un nuancier en porcelaine de Limoges

*Please contact our Sales Department for any further information,
Do not hesitate to ask for a colour chart made out of Limoges Porcelain.*

TÉLÉPHONE
(33) 05 55 30 23 67

FAX
(33) 05 55 30 83 46

E-MAIL
INFO@MERIGOUS.FR

Accessoires
de salle de bain
Bathroom accessories

DESIGN BODO SPERLEIN

Miroir - *Mirror*



0830 05 100

Porte savon - *Soap dish*



0253 05 100

Paire gobelets - *Tumbler pair*



0750 05 100

ART DECO

Porte savon - *Soap dish*



0080 06 100

Porte serviette - *Single towel rail*

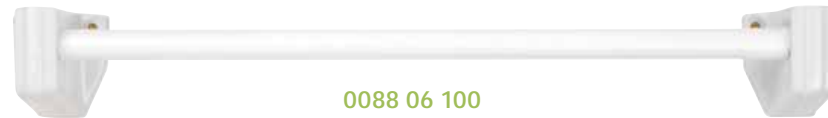

0088 06 100

Tablette miroir - *Mirror shelf*

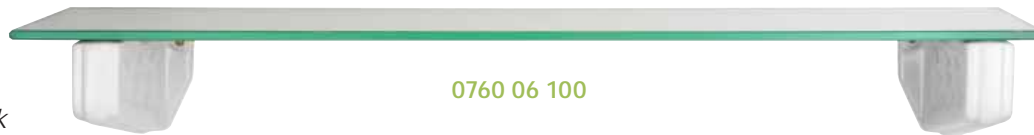

0760 06 100

Porte peignoir - *Robe hook*



0086 06 100

Crochet - *Hook*



0755 06 100

Bande 4 crochets - *4 hooks*



0758 06 100

PORTE PEIGNOIR ROBE HOOKS



0230 01 505



0086 01 100

PORTE TORCHONS - DISHCLOTH HOLDERS



0210 03 423



0210 03 427



0210 03 428



0739 03 100



0739 03 505



0739 03 421



0739 03 426



7311 11 100

Code article Item code	Largeur mm Width mm	Hauteur mm Height mm
0230 01 505	45	97
0086 01 100	83	75
0739 03***	30	100
0210 03***	50	115
7311 11***	50	225
0755 01 100	30	60
0756 01 100	30	120
0757 01 100	30	180

PORTE GANTS - HOOKS



0755 01 100



0756 01 100



0757 01 100

PORTE SAVONS - SOAP DISHES



0093 01 100



0816 01 100



0080 01 100

VERRES À DENTS - TUMBLERS



0817 01 100



0750 01 100



0750 10 100

PORTE SERVIETTES - TOWEL RAILS



0087 01 100

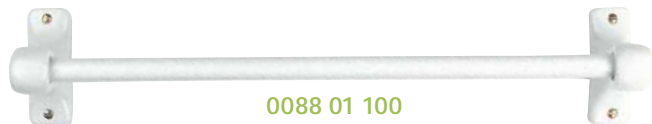

0088 01 100

ACCESSOIRES POUR WC TOILET ACCESSORIES

0084 01 100

0095 01 100



0085 01 100



0764 01 100



0947 01 100

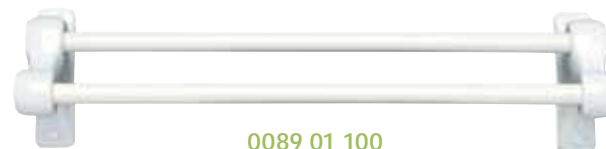

0089 01 100

Code article Item code	Largeur mm Width mm	Hauteur mm Height mm
0093 01 100	135	60
0816 01 100	112	75
0080 01 100	150	57
0817 01 100	60	83
0750 01 100	69	83
0750 10 100	69	83
0087 01 100	210	190
0088 01 100	470	100
0089 01 100	470	130
0085 01 100	150	148
0947 01 100	155	111

Divers

Miscellaneous

SIGNALÉTIQUE INTÉRIÈRE POUR PORTE - *INDOOR PLATES*

90 x 65 mm



V0063 30 558



V0063 30 159-2



V0063 30 110



V0063 30 016

Picto
Ø 80 mm

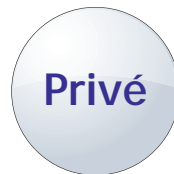

V7398 11 100-4



V7398 11 100-1

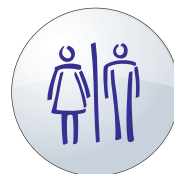

V7398 11 100-3

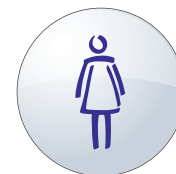

V7398 11 100-2

Maison de retraite - *Old people home*

100 x 75 mm



V7373 30 100MR



V0062 30 110

SIGNALÉTIQUE EXTÉRIÈRE PLAQUES DE RUE - *OUTDOOR PLATES*

150 x 110 mm



V7385 30 419



V7377 30 419

BOULES DE RAMPE - *STAIRCASE KNOBS*

Ø 100 mm



V0600 11 100



V0603 11 100



V0604 11 402

POIGNÉES DE TIRAGE *PULL HANDLE*

Poignée porte battante - *Swing door pull handle*

EA 205 mm



V0744 11 100

EA 205 mm



V0753 11 100

Bouton de chaînette blanc laiton - *Fix pull door knob*

Ø 70 mm

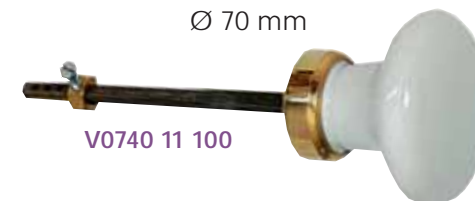

V0740 11 100



V0296 09 120-1



V0296 09 120-2

Nous fabriquons des pièces en porcelaine pour des créatrices de bijoux en porcelaine.
We make on measure porcelain parts for the creators of jewelry who wish porcelain.

BIJOUTERIE BOUCLES D'OREILLE - EARRINGS



V0295 09 120-1



V0295 09 120-2

Nous fabriquons des pièces en porcelaine pour des créateurs de bijoux en porcelaine.
We make on measure porcelain parts for creators of jewelry who wish porcelain.

BIJOUTERIE PENDENTIF - PENDANTS



0406 20 120/B1 0406 20 120/A

HUMIDIFICATEURS - HUMIDIFIERS

Décors disponibles : oiseaux, vieux métiers de Paris.
Available decors : Birds, Paris Old Professions.

Fourni avec attache Laiton.
Supplied with brass hook.



PLAQUES OVALES - OVAL PLATES

Nous avons plusieurs dimensions de formes ovales, demander notre tarif spécial Plaques
Our oval plates come in many sizes Ask for our special price list.



PLAQUES RECTANGULAIRES - RECTANGULAR PLATES

Nous avons plusieurs dimensions de formes rectangulaires, demander notre tarif spécial Plaques
Our rectangular plates come in many sizes. Ask for our special price list.

PLAQUES RONDES - *ROUND PLATES*

Nous avons plusieurs dimensions de formes rondes. Demander notre tarif spécial Plaques.
Our round plates come in many sizes. Ask for our special price list.



MAGNETS

Nous réalisons des magnets avec décor ou logo (cadeaux d'entreprise). Demander notre tarif.
We make magnets with decor or logo. Ask for a quotation.



ENCRIER - *INK STAND*

Pour les boules de lit, les encriers pour pupitre d'école. Demander notre tarif.
Ask for a quotation for bed knobs for antique beds and ink stands.



COMPOSANTS ROBINETTERIE - *FAUCET COMPONENTS*

Pour les manettes d'inverseurs, pied de robinets, croisillons et autres accessoires, demander notre tarif spécial.
Please ask for our special price list for ceramic faucet/tap components.



PASTILLES ROBINETTERIE - *TAPS*

Pour les pastilles de robinetterie avec ou sans inscription, demander notre tarif spécial.
Please ask for our special price list for taps.



Sur mesure

Workshop

PORCELAINE TECHNIQUE
TECHNICAL CERAMIC



LEGRAND©



MAILLE COURTESY CHRISTELLE FAMILIARI©

DESIGN ET HABITAT
DESIGN AND HABITAT



DESIGN MARC AUREL© POUR METALCO

MOBILIER URBAIN
STREET FURNITURE



URBACER AVEC LE CONCOURS DE LA CCI DE LIMOGES ET DE LA DGIS PARADIGME©



« SUR MESURE »
« WORKSHOP »

MAROQUINERIE, MODE,
PRÊT A PORTER
FASHION - FANCY LEATHER CLOTHES
READY TO WEAR CLOTHES



FELICIE BAJARD©

FUNERAIRE
FUNERAL ACCESSORIES

CULTURE ET PATRIMOINE©
MAIRIE DE LIMOGES©



CULINAIRE MUSICAL INSTRUMENTS
CULINARY ART COMPONENTS



ACR©



WIKIPEDIA ©

BIJOUX DE CREATEURS
CREATIVE JEWELLERY



STEFANO POLETTI©

... Et de nombreuses expériences avec des DESIGNERS de renommée internationale...
Veuillez nous consulter pour toute étude de projet.

We work closely with internationally-renowned designers.
Please consult us for assistance with any of your projects.

